

Canon New F-1

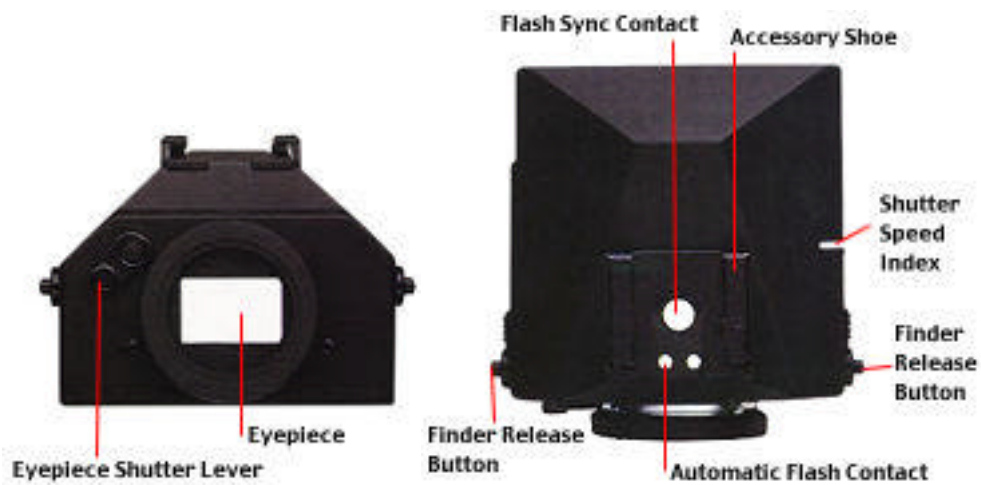

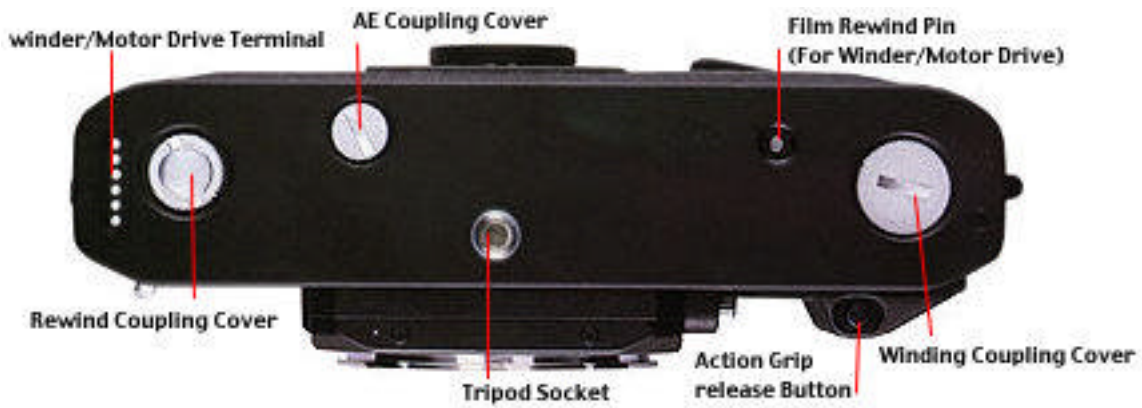

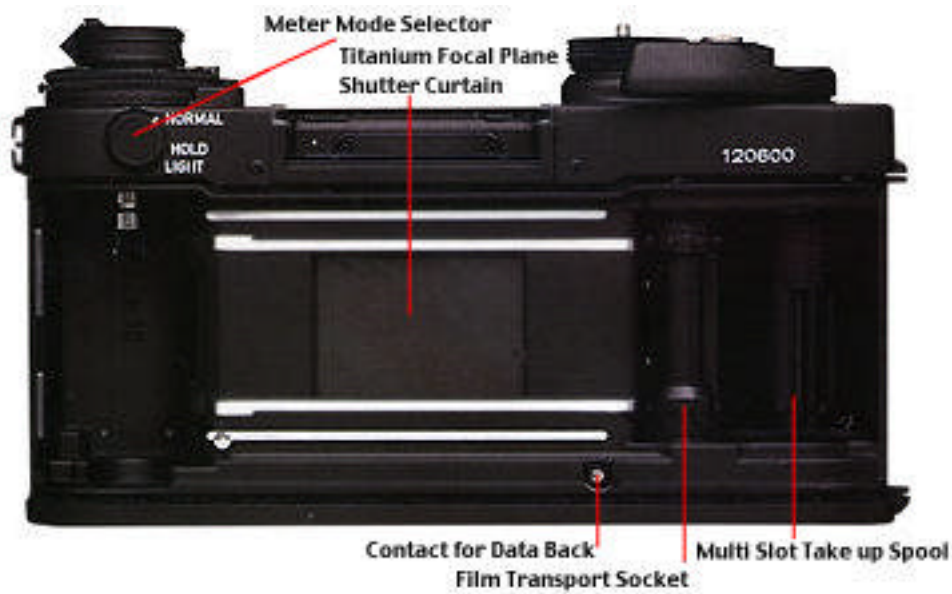

Film Speed Range

One of the widest ranges of any 35mm SLR, the ASA 6-6400 film speed provides plenty of latitude for push-processing films.

The ASA is clearly displayed in the window for easy reference.

Film Advance Lever

The film advance lever has a 30° stand-off angle for readiness in action photography. Contoured to fit the thumb for comfortable and efficient operation, the lever allows single or multiple stroke film advance.

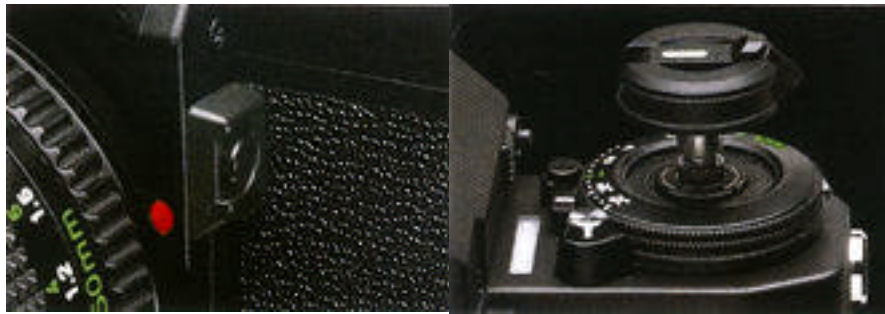

Battery Check Button

Press this button to monitor the battery condition. Power is sufficient if the meter needle moves above the battery check mark in the viewfinder. The button also serves to cancel the self-timer exposure meter and viewfinder illumination, as well as to release the second shutter curtain during long exposures.

Safety Stopper

A safety lock eliminates all risk of accidentally opening the camera back and exposing the film. To open, simultaneously depress the stopper and lift the rewind knob.

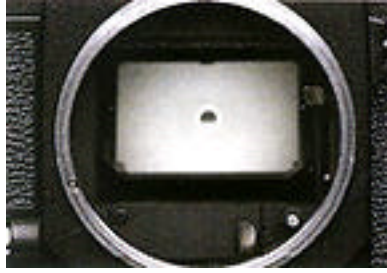

Canon Breech-lock Mount

The breech-lock mount is an exclusive feature which assures total interchangeability of all Canon lenses and accessories. Lens change is effected in one swift motion.



Exposure Compensation

Exposure compensation up to +2EV is possible for special creative effects. Calibrated in 1/3 EV increments, the dial is released by pressing the lock button.



Stop-down Slide

A convenient feature which allows you to check depth of field and perform stopped-down metering with FL or non-fully coupled close-up accessories.

Exposure Compensation

Exposure compensation up to +2EV is possible for special creative effects. Calibrated in 1/3 EV increments, the dial is released by pressing the lock button.



Eyepiece:

The eyepiece shutter shuts out all extraneous light. A useful safeguard when taking long exposures or with self-timed or remote-control photography.

Shutter Button/Self-timer

The multifunctional shutter button provides a meter reading when depressed gently and releases the shutter when fully depressed. To activate the selftimer, turn the outer ring to "S" and press the shutter. A beeping sound will issue for 10 secs. before the shutter releases itself. Set the ring to "A" for normal shutter release and "L" to lock the shutter.



Meter Mode Selector

An invaluable feature which helps you in more ways than one. At HOLD, the meter operates for 16 secs., freeing both hands to adjust the camera. The same happens on LIGHT, but in addition the viewfinder display is illuminated. At NORMAL, the meter functions only while the shutter button is depressed, to save power.



Shutter Speed Dial

Align the "A" mark with the index for aperture-priority. Full seconds (2, 4 and 8 sec.) are color coded yellow for clear distinction with faster speeds (plus "t" and "B") which are in white.



Contoured Action Grip

The specially shaped battery compartment cover provides a firm action grip for steadier shooting. Press the release button underneath to remove the cover and gain access to the battery.

Film Rewind/Multiple Exposure Lever

Traditionally located on the base, Canon has relocated the film rewind lever on top for easier access when using a tripod or other accessories. For film rewind, turn the lever clockwise and depress. Do the same thing before cocking the shutter to take multiple exposures. Rapid sequence multiple exposures are also possible using either of the power drives

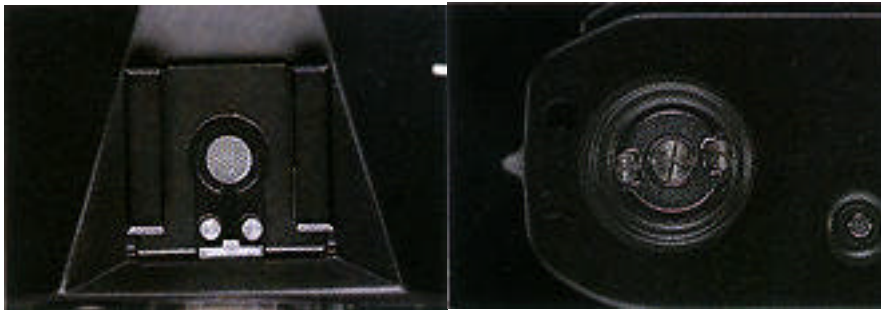

Accessory Shoe

Located on top of the pentaprism viewfinders for direct mounting of all Speedlites. Special contacts permit automatic setting of the 1/90 sec. flash sync speed and flash aperture when in shutterpriority AE mode.

Winder/Motor Drive Coupler

Remove the protective screw cap to connect either the AE Motor Drive FN or AE Power Winder FN. The power drives have a receptacle for storing the cap

Contents

1	Attaching the Lens	4
2	Battery	6
2.1	Loading the Battery	6
2.2	Checking the Battery	7
3	Shutter Release and Self-timer/Lock Lever	9
4	Holding the Camera	11
5	Focusing	12
6	Loading the Film	14
7	Setting the ASA/ISO Film Speed	15
8	Frame Counter	16
9	Exposure	18
10	Shutter	19
11	How to Choose a Shutter Speed	21
11.1	Freezing Motion	21
11.2	Blurring the Subject's Motion	22
11.3	Panning	22
12	Aperture	23
13	Exposure Modes	25
13.1	Full-aperture Metering	25
13.2	Stopped-down Metering	26
14	Meter Mode Selector	27
15	Which viewfinder did you purchase?	28
16	Eye-Level Finder FN	29
16.1	Match-needle Metering	29
16.2	Stopped-down (Fixed-index) Metering	32
17	AE Finder FN	33

18 Aperture-priority AE	33
18.1 Stopped-down AE	35
18.2 Match-needle Metering	36
18.3 Stopped-down (Fixed-index) Metering	36
19 Shutter-priority AE	38
20 Meter Coupling Range	41
21 Metering Sensitivity Areas	42
22 Exposure Compensation	45
23 Rewinding the Film	50
24 Depth of Field	52
25 Self-timer	54
26 Multiple Exposures	57
27 Exposure in Multiple Exposures	60
28 Flash Photography	61
28.1 AE Flash Photography with Speedlites 011A, 133A, 155A, 166A, 177A, 188A, 199A, 533G and 577G.	61
28.2 Slow-sync Flash Photography	62
28.3 General Flash Photography	63
29 Shooting with Close-up Accessories	65
30 System Accessories	71
30.1 Canon AE Motor Drive FN	71
30.2 Canon AE Power Winder FN	72
30.3 Canon Film Chamber FN-100	73
30.4 Canon Data Back FN	74
30.5 Canon Wireless Controller LC-1	75
31 Specification	76

1 Attaching the Lens



To remove the body cap, turn it counterclockwise until it stops and pull it off. To reattach, align the red dot on the cap with the camera's red dot. Then lightly push the cap in and turn it fully clockwise.

Turn the rear lens cap in the direction of the arrow until it stops and pull it off. To reattach, align the arrow on the cap with the lens' red dot. Then lightly push the cap in and turn it fully clockwise.

To mount the lens, align its red positioning point with the camera's red dot and turn the lens in the direction of the arrow until it stops and the lens release button pops out. To remove the lens, turn it counterclockwise while pressing the lens release button.



CAUTION

Do not mount the lens if the red dot inside the camera mount and the red line on the stop-down slide are showing. In this case, push in the stopdown slide so that it locks in the normal (retracted) position and these warning marks can no longer be seen.

1 ATTACHING THE LENS

The following lenses cannot be mounted on the New Canon F-1:

FL	19mm	f/3.5	R	100mm	f/3.5
FL	58mm	f/1.2	R	100mm	f/2
R	50mm	f/1.8	FLP	38mm	f/2.8
R	58mm	f/1.2			

Notes:

- Do not push the stop-down slide while advancing the film. Otherwise, it may be impossible to mount the lens.
- Do not press the lens release button while mounting the lens or it may not pop out, thus causing the lens to work incorrectly.

2 Battery

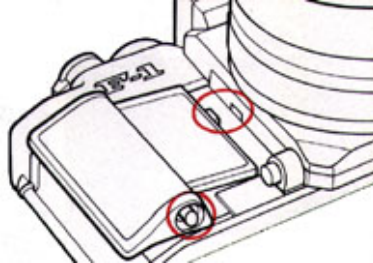

2.1 Loading the Battery

The action grip of the camera also serves as a battery chamber cover and therefore must be removed to load a battery. To do this, press the release button and lift up the grip.

Use one of the batteries listed below or an equivalent of another brand:

Lithium 6V	Duracell PX 28L
Alkaline - manganese 6V	Eveready (UCAR) No. A544 IEC 4LR44
Silver Oxide 6V	Eveready (UCAR) No. 544, Duracell PX 28, IEC 4SR44

To ensure proper contact, wipe the battery terminals with a clean, dry cloth before loading. Load a new battery so that its terminals are in the directions indicated by the diagram inside the battery chamber. Insert the negative end first, then push down and insert the positive end. The camera will not function if the battery is loaded incorrectly.

Then slide the action grip's tab into the guide hole as shown, and lower the grip until it locks in place.

2.2 Checking the Battery



The battery can be checked with the shutter dial at any setting other than "A", and at any ASA/ISO film speed setting. With the shutter dial on "B," battery check is possible only after the film has been advanced. To check the battery, press the check button for about three seconds while looking in the viewfinder. Battery power is sufficient when the meter needle is above the battery check index. The weaker the battery, the lower the needle. However, even if the battery is weak, exposure will still be correct as long as the shutter is released when you press the shutter button. If the meter needle rests at or below the index, the battery is almost exhausted. In this case, have a new battery ready.

With normal use the battery should last about one year. Battery power may decrease, however, at temperatures below 0° C (32° F). In this case, load a new battery and keep the camera warm until you are ready to shoot. Do not throw the original battery away; keep it as a spare. Alternate the two batteries, keeping the one that is not in use warm. Although a battery may not perform well in the cold, it may work normally again at higher temperatures. Lithium batteries are recommended for use at low temperatures.

IMPORTANT

The New Canon F-1 can be used even if the battery fails simply by removing the exhausted battery from the camera. The mechanically controlled shutter speeds are 1/2000 to 1/125 sec., "S" (1/90 sec.) and "B" (bulb).

Notes:

- Remove the battery if you do not expect to use the camera for about three weeks or longer.
- Do not try to take the battery apart and never dispose of it in fire.

Try to make a habit of checking the battery at the following times:

- After loading a new battery.
- If the shutter won't function with the self-timer/lock lever on "A."
- Before and after making many long exposures at slow speeds other than "B."
- When you are using the camera at low temperatures.
- Before shooting important events.
- When the camera is used frequently.
- After storing the camera for a long time.
- Before going on a trip.

The battery check button also serves to cancel the self-timer, meter reading, illumination of viewfinder information ("LIGHT" setting of meter mode selector), and shutter operation during long exposures. The circuit is cancelled the moment you press the button, and the second curtain will close when you remove your finger. The shutter will not be released if you press the shutter button while pressing the battery check button.

3 Shutter Release and Self-timer/Lock Lever



The self-timer/lock lever of the camera has three settings. With the lever at "A," press the shutter button halfway to activate the meter. To release the shutter, gently press the shutter button all the way down. When the level is at "L," the shutter button is locked. It is advisable to turn the lock lever to "L" when the camera is not in use to prevent accidental shutter release and battery consumption. With the lever at "S," the camera's 10-second self-timer can be activated simply by pressing the shutter button. For further details on self-timer photography.

Shutter release is electromagnetic as long as there is a battery in the camera. Once the battery is removed, the camera switches to mechanical release, and only those speeds which are mechanically controlled can be used. The shutter button has a threaded socket in the center to accept a standard cable release.

IMPORTANT

The New F- 1 has a built-in safety circuit which prevents shutter release if the lens aperture ring is on the "A" mark and a power drive is not attached.



First push the advance lever out to its 30° stand-off position. To advance the film, turn the advance lever all the way to the right in one continuous 139° stroke or several short ones. This also cocks the shutter and prepares the diaphragm and

3 SHUTTER RELEASE AND SELF-TIMER/LOCK LEVER

mirror for the next shutter release. The film must be advanced fully to the next frame or the shutter will not release.

4 Holding the Camera



The best way to prevent image blur from camera movement is to hold the camera as steady as possible, with your left hand supporting the camera and lens. Lightly rest your right index finger on the shutter button, and the tip of your thumb on the film advance lever or on the body. Wrap your other right fingers around the action grip. Then press your left elbow to your body and lightly press the camera against your cheek or forehead. For a vertical shot, steady at least one elbow against your body. Spread your feet slightly apart, one foot ahead of the other, and relax. Lean against a steady support if one is available.

There is, of course, no one correct way to hold the camera.

Experiment to find the most suitable way for you. Select a method that provides comfort in addition to stability. It may help to practice in front of a mirror.

When shooting at a shutter speed of 1/30 sec. Or slower or with a telephoto lens, it is advisable to mount the camera on a tripod. If the tripod screw is especially long, be careful not to screw it in beyond the limit of the camera's tripod socket.

5 Focusing

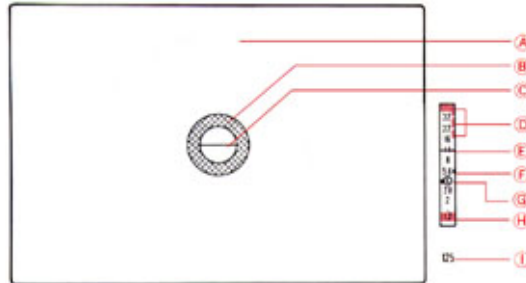

1. Laser-matte screen
2. Microprism rangefinder
3. New split rangefinder
4. Overexposure warning mark
5. Meter Needle
6. Stopped-down metering/battery check index
7. Aperture needle
8. Underexposure warning mark (when using f/1.4 lens)
9. Shutter speed display

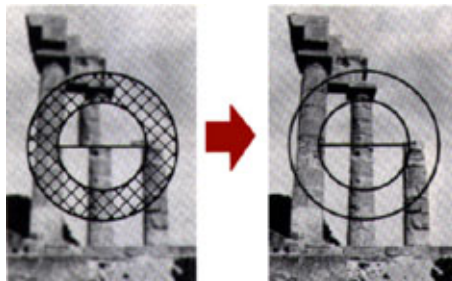

out of focus

in focus

Turn the focusing ring of the lens as you look in the viewfinder until the main subject is sharp. The three focusing aids of the standard screen can be used alone or in combination according to the subject and your own preference.

Note:

The New Canon F- 1's focusing screen, which makes precise focusing possible, also determines the metering sensitivity area. There are 13 types of focusing screens and three different metering areas optionally available to suit your particular focusing and metering requirements.

1. New Split Rangefinder

The new split-image rangefinder divides the subject in half horizontally and is especially useful for a subject which has vertical lines. The subject is in focus when the two halves merge to become one unbroken image. When using a lens with a maximum aperture of $f/5.6$ or smaller, one-half of the split-image rangefinder may take on a slight color.

2. Microprism Rangefinder

When the subject is out of focus, the microprism ring breaks the subject into tiny fragments, causing a shimmering effect. It is clear and steady when your subject is in focus.

3. Laser-matte Screen

The laser-matte screen appears fuzzy until the subject is in focus. It is particularly effective when you are using accessories for copying or close-ups.

Note:

Ten eyesight correction lenses from +3 to -4 diopters are available. They may make viewing and focusing easier if you are near- or farsighted. Choose the one closest to your eyeglass prescription, then make a practical test if possible.

6 Loading the Film



Pressing the safety stopper, pull up the rewind knob until the camera back pops open. Be sure to shield the film from direct sunlight while loading. Place the cartridge in the film chamber as shown. Then push down the rewind knob, turning it until it drops into its normal position.

Note:

Remove the plastic insert from the pressure plate before loading the first film cartridge.



Pull the film leader across the camera and insert the tip into any slot of the take-up spool.

Advance the film once. Make sure the sprocket teeth engage the film perforations. The film should be taut. If there is any slack, unfold the rewind crank and gently turn it in the direction of the arrow until it stops. Note that the rewind crank must be unfolded before you turn it; otherwise, the knob will turn freely. Then fold the rewind crank back in. Close the camera back.

Take several blank shots, releasing the shutter and advancing the film until the frame counter reaches "1." While doing this, keep an eye on the rewind knob. If it rotates in the direction of the arrow, the film is loaded correctly.

CAUTION

NEVER remove the camera's rewind coupler cover from the baseplate when film is loaded in the camera. This will expose the film to light. It is not necessary to remove the coupler cover except for attaching the AE Motor Drive FN.

7 Setting the ASA/ISO Film Speed



Turn the setting dial, while pressing the lock release button, until the desired film speed aligns with the index. The dial cannot be turned lower than ASA6 or higher than ASA6400. The table on the next page shows the ASA/ISO film speeds which can be set on the New Canon F-1. Figures in parentheses are intermediate speeds which are indicated by dots on the ASA/ISO dial.

ASA/ISO is a numerical rating of the film's sensitivity to light. The higher the number, the faster the film and the more sensitive it is to a given amount of light as compared to a film with a lower number. The film manufacturer's ASA/ISO rating can be found on the film cartridge, the carton, and the data sheet.

6	•	12	•	25	•	50	•	100	•	200	•	400	•	800	•	1600	•	3200	•	6400
(8)	(10)	(16)	(20)	(32)	(40)	(64)	(80)	(125)	(160)	(250)	(320)	(500)	(650)	(1000)	(1250)	(2000)	(2500)	(4000)	(5000)	

8 Frame Counter

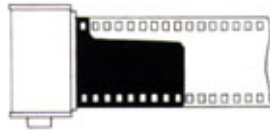

Each time you advance the film, the frame counter also advances to the next number. It can count up to 39 frames. The numbers 1, 12, 20, 24 and 36 are in orange, the latter four to call attention to the fact that rolls with those numbers are or are almost finished. The frame counter automatically returns to "S" when you open the camera back. During multiple exposures, the frame counter advances each time you wind the advance lever.

The New Canon F-1 will also accept bulk film loaded into standard cartridges. In this case, be sure to trim the leader as shown before loading it into the camera.



Memo Holder

The camera back has a memo holder. It conveniently holds the end of the film box as a reminder of the type of film in use and the number of exposures.



9 Exposure

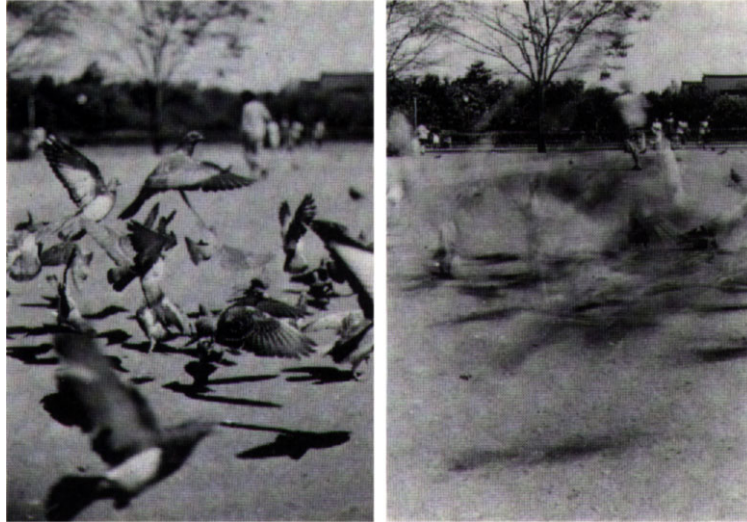

The amount of light that exposes a frame is determined by the aperture and shutter speed. The size of the aperture controls the amount of light allowed to reach the film, while the shutter speed controls how long the light strikes the film. For the same exposure, a change in shutter speed requires an equal and opposite change in aperture, and vice versa. There are usually several combinations of shutter speed and aperture which will give the same exposure. If, for example, the meter indicates that exposure will be correct at $f/4$ and $1/60$ sec., you usually have other combinations to choose from. Some of the combinations in this example include $f/5.6$ at $1/30$ sec. and $f/2.8$ at $1/125$ sec. The two main considerations involved in selecting one particular combination over the others are the subject's motion and depth of field; each of these affects the way a picture will look. You can control the effect of a picture simply by choosing a certain shutter speed and aperture combination. The next three sections provide information which you may find useful whether you are using the camera manually or automatically with an AE accessory.

10 Shutter

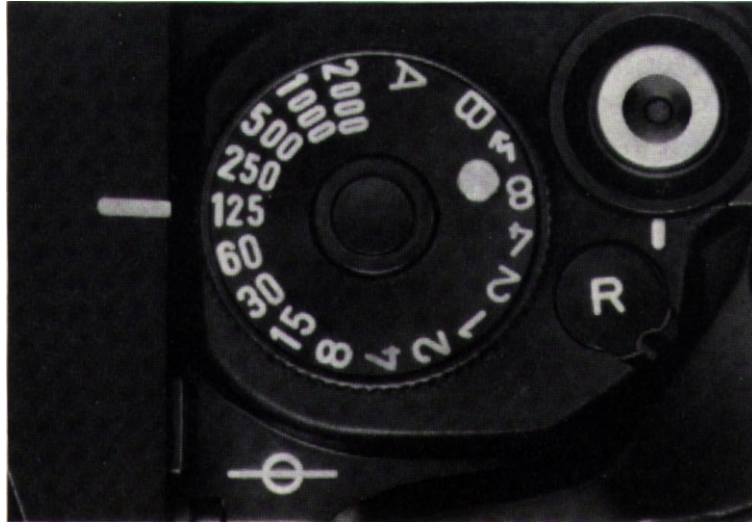

The New Canon F-1's hybrid shutter is electronically as well as mechanically controlled. Shutter speeds from 1/2000 to 1/125 sec., "f" (1/90 sec.) and "B" (bulb) are mechanically governed, while 1/60 to 8 sees. are electronically controlled. With the AE Finder FN attached and the shutter dial on "A," shutter speeds from 1/1000 to 8 sees. are electronically controlled.

The shutter dial of the camera has settings from 2000 to 8, "A," "f," and "B." The slow shutter speeds from 2 to 8 seconds are in yellow, while shutter speeds from 1 to 1/2000 sec. are in white. The white numbers are reciprocals of the true shutter speeds; "125," for example, indicates a speed of 1/125 sec. Intermediate settings on the dial cannot be used, and the dial cannot be turned between "B" and "A."

The red "A" is for shooting in the aperture priority and stopped-down AE modes with the Canon AE Finder FN attached. For this setting, pull up the outer ring and turn the dial until "A" is aligned with the index on the finder. A scale with shutter speeds from 8 to 1/1000 sec. will now be displayed below the field of view as long as the AE Finder FN is attached.

The "t" setting is for synchronized flash photography at an X sync. speed of 1/90 sec. It is not necessary to set the shutter dial to "t" when using a dedicated Canon Speedlite; once the Speedlite's pilot lamp glows, the camera automatically switches to 1/90 sec. provided the shutter dial is not on "B."

When the shutter dial is set to "B," the shutter will remain open as long as you press the shutter button. The camera's meter will not give a reading on "B," thus AE photography and match-needle metering are impossible. You will have to experiment or use a separate exposure meter to find the best exposure. It is advisable to use a tripod and locking cable release for long exposures.

Since "B" is mechanically controlled, the battery will not be drained on this setting

regardless of the exposure duration.

To cancel shutter operation during a long exposure, press the battery check button.

Mechanical Operation

There are several shutter speeds available with the New Canon F-1 even if the battery fails. In this case, remove the battery from the battery chamber. Shutter speeds from 1/2000 to 1/125 sec. , "S" (1/90 sec.) and "B," which are all mechanically controlled, can be used. If the shutter dial is set to any speed between 1/60 and 8 secs., the camera switches automatically to 1/90 sec. when you press the shutter button.

IMPORTANT

The camera will not operate if you leave the exhausted battery in the battery chamber.

11 How to Choose a Shutter Speed

The shutter controls exposure by the length of time it remains open. The basic function of shutter speed is to provide correct exposure, but you can also use it to control the expression of your subject's motion and to control the effect of camera movement.

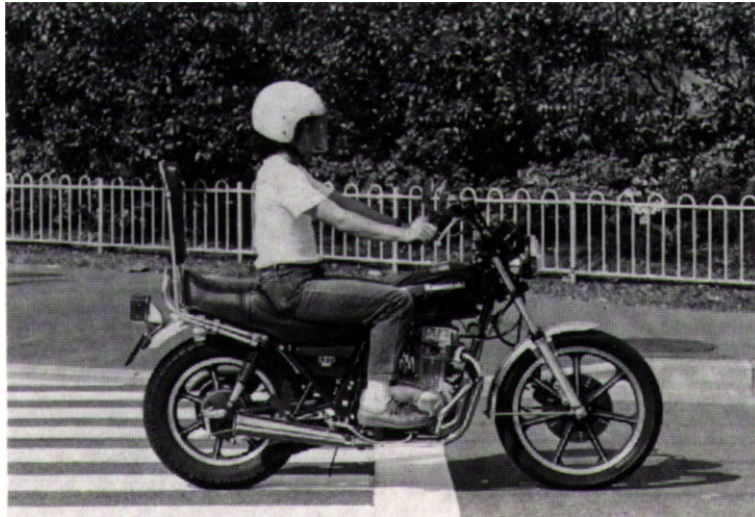

11.1 Freezing Motion

The faster the subject is moving, the higher the shutter speed required to stop the action. To freeze the motion of a pedestrian, for example, choose a speed of at least $1/60$ sec.; for a moving car, as fast as $1/1000$ sec. The motion of the motorcycle in this photo was frozen at $1/2000$ sec.

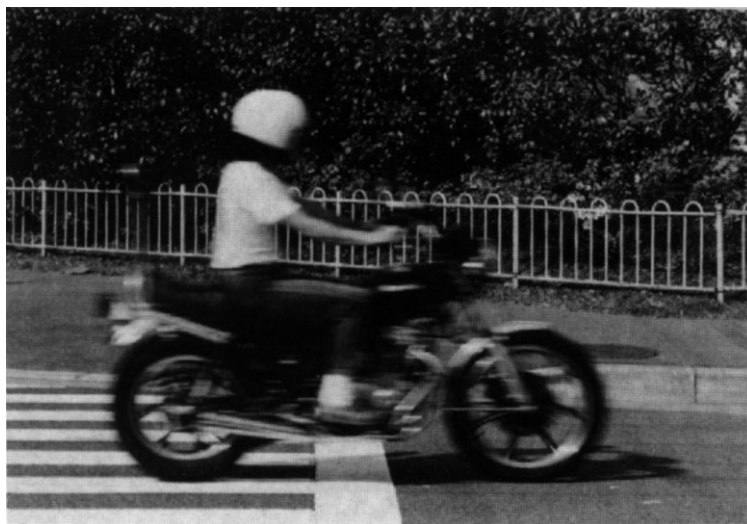

11.2 Blurring the Subject's Motion

Blurring part of the picture can give a convincing sense of action. To blur the subject, simply set a shutter speed which is too slow to freeze its action. In this photo it was blurred at 1/15 sec.



11.3 Panning

You can blur the background while keeping the subject relatively sharp by "panning." Choose a shutter speed suitable for the subject's motion and release the shutter as you follow the movement, turning the upper part of your body.

Blurring part of the picture can heighten the sense of action. In most cases, however, image blur is undesirable. To avoid blurred pictures from camera movement, choose a shutter speed of at least 1/60 sec. for handheld shooting with a standard lens.

With a telephoto lens, it is advisable to use faster shutter speeds. The rule of thumb is to use a shutter speed no slower than the reciprocal of the lens in use. This means that for a 100mm lens, the shutter speed should be at least 1/125 sec.; for a 500mm lens, it should be at least 1/500 sec.

12 Aperture

The size of the aperture determines the amount of light allowed to reach the film. The apertures are indicated by a series of numbers, called f/stops or f-numbers, which can be found on the aperture ring. The smaller numbers are called large f/stops while the larger numbers are called small f/stops. This is because the smaller numbers represent larger apertures which allow more light to pass through the lens. The largest f/stop on the lens is called the lens maximum aperture; the smallest f/stop the lens minimum aperture. The maximum and minimum apertures differ depending on the lens.

Each time you turn the aperture ring from one f/stop to the next smaller one, the amount of light allowed through is exactly halved. Using f/2 as a standard, the amount of light striking the film will change according to the f/stop indicated below.

How the Aperture Affects the Picture

In addition to controlling the quantity of light, the aperture influences depth of field which, in turn, affects the way a picture will look. When your subject is in focus, there is a certain area in front of and behind it which will also be in focus. This range of sharpness is called depth of field.

f/stop	(1.2)	1.4	(1.8)	2	2.8	4	5.6	8	11
Brightness ratio	3	2	1-1/4	1	1/2	1/4	1/8	1/16	1/32
f/stop	16	22	32						
Brightness ratio	1/64	1/128	1/256						



The smaller the aperture, the wider the range of sharpness. This is illustrated by the picture above which was taken at $f/22$. Compare it with the photo to s right. This extended depth of field is especially good for such subjects as landscapes.

The larger the aperture, the narrower the range of sharpness. An aperture of $f/1.4$, for instance, can isolate your subject from its surroundings. This is often used to blur a disturbing background in portraiture.

Depth of field is also greater the shorter the focal length of the lens. A 24mm lens, for example, will show greater depth of field than a 50mm lens, provided the aperture and shooting distance are the same. Depth of field is also greater the longer the shooting distance, and is generally greater in the background than in the foreground by a ratio of two to one.

13 Exposure Modes

The New Canon F-1 is basically a manual-exposure camera capable of through-the-lens, full-aperture metering and stopped-down metering with the Eye-Level Finder FN. It can be converted to automatic exposure (AE) simply by attaching the suitable AE accessory, such as the AE Finder FN for aperture-priority AE, or the AE Power Winder FN or AE Motor Drive FN for shutter-priority AE. Manual exposure is still possible with one or both of these accessories attached.

The following exposure modes are possible with the New Canon F-1:

- Match-needle Metering
- Shutter-priority AE
- Aperture-priority AE
- Stopped-down (Fixed-index) Metering
- Stopped-down AE

Detailed information of these modes is provided in the sections entitled "Eye-Level Finder FN," "AE Finder FN," and "Shutter-priority AE."

13.1 Full-aperture Metering

With a Canon FD lens, metering is done with the lens at maximum aperture. This is called "full-aperture metering." The lens diaphragm does not close down until the shutter is released. Afterwards, it reopens automatically to the maximum aperture. One of the primary advantages of full-aperture metering is that you are able to view and meter the subject with the viewfinder at its brightest.

1. Match-needle Metering

Set the desired shutter speed and turn the lens' aperture ring until the meter needle bisects the aperture ring. The position of the meter needle is determined by the film speed, shutter speed and the lighting conditions. This manual mode is suitable for virtually all subjects.

2. Shutter-priority AE

Set the desired shutter speed and the camera automatically selects the proper aperture according to lighting conditions. This AE mode is suitable for most subjects but especially useful in action photography.

[For this mode, the AE Power Winder FN or AE Motor Drive FN must be attached to the camera and the lens set to the "A" mark.]

3. Aperture-priority AE

Set the lens to the desired aperture and the camera automatically selects the proper shutter speed according to the lighting conditions. This AE mode is useful for portraiture and still photography such as landscapes where depth of field is of importance.

[For this mode, the AE Finder FN must be attached to the camera and the shutter dial set to "A"]

13.2 Stopped-down Metering

Stopped-down metering is necessary whenever you are using a non-FD lens, such as the Reflex 500mm, which has a fixed aperture, the TS 35mm lens or any of the older FL lenses. It is also necessary whenever you insert accessories which do not have a full-aperture signal pin, such as bellows or extension tubes, between the camera body and lens. Stoppeddown metering is possible, though unnecessary, with an FD lens. For correct exposure, set an aperture smaller than f/2.8.

For stopped-down metering, the lens diaphragm must be closed down (stopped down) to the working aperture. Since the diaphragm will open and close as you turn the lens'aperture ring, depth of field can be easily checked.

1. Stopped-down (Fixed-index) Metering

Set an aperture and unlock the stop-down slide by pushing it in and then releasing it. Turn the shutter dial (or aperturering) until the meter needle is in line with the stopped-down metering index.

2. Stopped-down AE

Set an aperture and unlock the stop-down slide by pushing it in and then releasing it. The camera will automatically select the proper shutter speed for the lighting conditions.

This AE mode is especially advantageous in such fields as photomacrography and photomicrography.

[For this mode, the AE Finder FN must be attached to the camera and the shutter dial on "A."]

14 Meter Mode Selector

There are three ways to turn on the meter, each designed to suit particular metering requirements. To set a meter mode, simply turn the mode selector so that its index aligns with the desired setting.

NORMAL

The meter turns on only while the shutter button is pressed halfway (except for "B" and "S" settings on the shutter dial). This mode is suited for AE photography.

HOLD

The meter turns on the moment you press the shutter button halfway and stays on for 16 seconds even if you remove your finger from the shutter button. It automatically turns off after the specified time, thus conserving battery power. This mode is particularly suited for manual exposure and any situation in which you need more time to meter.

LIGHT

As on "HOLD," the meter, once activated, stays on for 16 seconds even if you remove your finger from the shutter button. In addition, the aperture scale in the viewfinder is illuminated for the same period of time. This mode allows you to meter in low-light situations.

In the "HOLD" and "LIGHT" modes, you can cancel the meter reading any time within the 16 seconds simply by pressing the battery check button. Each mode-ids also cancelled when the shutter is released. If you have turned on the meter on the "LIGHT" setting and wish to cancel only the illumination, turn the mode selector to "HOLD" or "NORMAL." The meter will continue to read, automatically turning off after 16 seconds.

Note:

With the AE Finder FN attached and the shutter dial set to "A," a different scale than that used for match-needle metering displays exposure information for aperture-priority and stopped-down AK. Consequently, there is no display illumination in the "LIGHT" mode when the shutter dial is on "A."

15 Which viewfinder did you purchase?



Eye-Level Finder FN

AE Finder FN

16 Eye-Level Finder FN

With the Eye-Level Finder FN, an aperture scale and the pre-set shutter speed are displayed to the right of the field of view. Focusing Screen FN-PE, which offers selective-area metering, is supplied with the New Canon F-1 Eye-Level Finder combination.

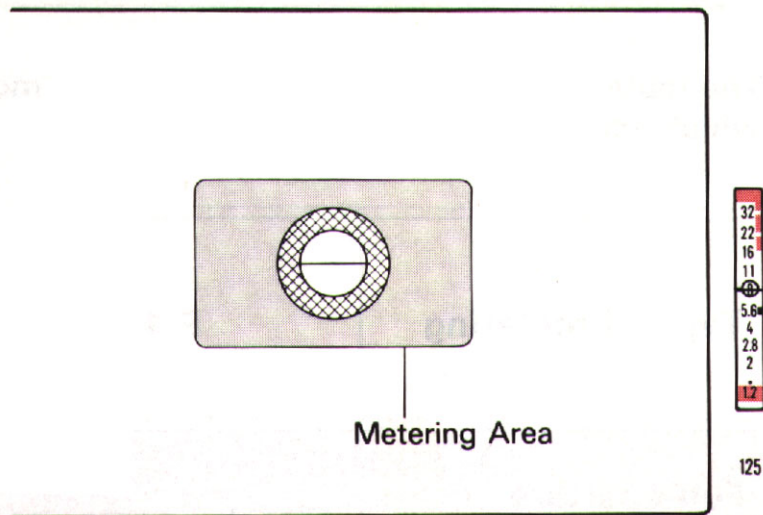

16.1 Match-needle Metering

1. Turn the shutter dial to the desired speed.
2. Look into the viewfinder and focus the subject.

3. Place your subject so that it fills the rectangular area in the center of the viewfinder. This shaded portion is the light measuring area of the camera's silicon photocell and is 12% of the field of view.
4. Turn the meter mode selector to the desired mode. Then lightly press the shutter button halfway to turn on the meter.
The meter needle should be outside of the exposure warning zones. If it is in either zone, turn the shutter dial until the meter needle moves out of the zone.
5. For correct exposure, turn the lens' aperture ring until the center of the aperture needle aligns with the meter needle. The diameter of the circle is equivalent to one f/stop, and exposure adjustment is possible in one-half f/stop increments simply by turning the lens' aperture ring.

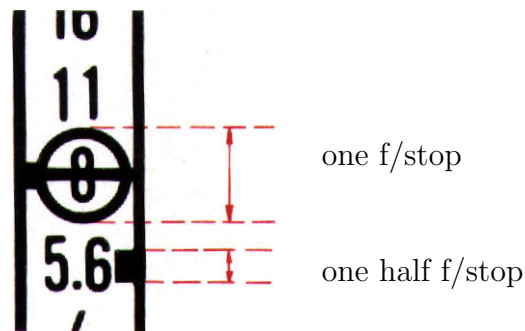
**Notes:**

- The aperture needle moves only between the minimum and maximum apertures of the lens in use.
- The meter does not operate with the shutter dial on "B" or "S".

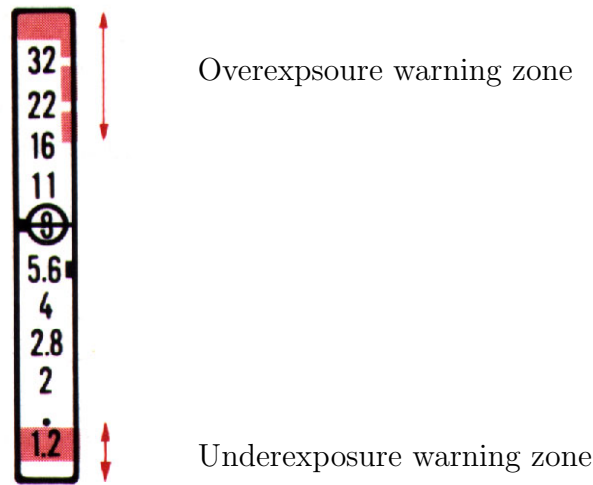

Underexposure Warning

The position of the red underexposure warning mark is determined by the lens' maximum aperture. If the meter needle points to the underexposure mark, choose a slower shutter speed until the needle moves away from the mark.

Overexposure Warning

The red marks next to 32, 22 and 16 in the aperture scale are overexposure warning zones. If the meter needle points to one of these zones, check the lens' minimum aperture. If, for example, the meter needle points to the red zone between $f/16$ and $f/22$ and the minimum aperture is $f/16$, turn the shutter dial to a faster speed until the meter needle points to an aperture of $f/16$ or larger.

16.2 Stopped-down (Fixed-index) Metering



1. Turn the shutter dial to the desired speed.
2. Look into the viewfinder and focus the subject.
3. Unlock the stop-down slide. To do this, push it in and then release it; the slide will unlock and its red line can be seen. The aperture needle will disappear from view with the stop-down slide extended.
4. Turn the aperture ring (or shutter dial) until the meter needle is aligned with the stopped-down metering/battery check index. Choose a slower speed if the meter needle rests below the index, or a faster speed if the meter needle rests above the index.

Notes:

- You can also set the aperture first and then turn the shutter dial until the meter needle aligns with the index. However, since intermediate settings on the shutter dial cannot be used, minor exposure adjustments must be made with the lens' aperture ring.
- The height of the stopped-down metering index is equivalent to one-half f/stop.

17 AE Finder FN

The primary role of the AE Finder FN is to convert the camera to aperture-priority AE or stopped-down AK. For these two modes, a shutter speed scale and, with a New FD lens mounted, the pre-set aperture are displayed below the field of view. Manual exposure is also possible with the finder. In manual, the aperture scale and shutter speed are displayed to the right of the field of view. Thus AE and manual modes are clearly differentiated and you know immediately in which mode the camera is set simply by the location of the exposure information. Focusing Screen FN-AE, which provides center-weighted average metering, is supplied when the New Canon F-1 is purchased initially with an AE Finder FN.

18 Aperture-priority AE

1. After attaching the AE Finder FN, set the shutter dial to "A." To do this, pull up the outer ring and turn the dial until "A" is aligned with the index on the finder. The shutter dial cannot be turned between the "A" and "B" settings.
2. Turn the lens' aperture ring to the desired aperture.
3. Look into the viewfinder and focus the subject.
4. Turn the meter mode selector to "A". Then press the shutter button halfway to turn on the meter. Exposure will be correct as long as the meter needle is not pointing to either of the exposure warning zones. If the meter needle is in either zone, turn the aperture ring until it moves out of the zone.
5. To release the shutter, press the shutter button all the way down.

There is a possibility of camera movement if the meter needle indicates a shutter speed of 1/30 sec. or slower. In this case, choose a larger aperture until the shutter speed indicated is 1/60 sec. or faster. If you have set the maximum aperture and the shutter speed is still slower than 1/60 sec., attach the camera to a tripod, use a flash or add artificial light.

On the other hand, if the meter needle indicates over exposure even after you have set the maximum aperture, attach a neutral density (ND) filter to the lens. This will reduce the amount of light to the film.

Notes

If the shutter dial is set to "A" before the finder is attached, exposure information

will not be displayed. In this case, first turn the shutter dial to "2000," then back to "A."

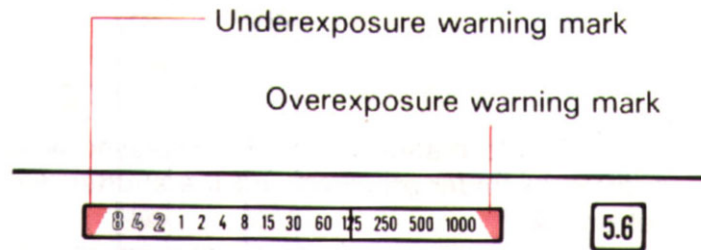
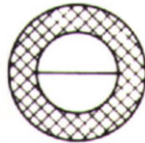

Notes:

- Exposure information will not be displayed with a different finder attached and the shutter dial set on "A."
- With a New FD lens "without chrome mount ring), the aperture is displayed adjacent to the shutter speed scale in the viewfinder. It is impossible, however, to read the aperture when using an FD lens with a chrome mount ring or when using an extender, extension tubes or other close-up accessories between the camera body and lens.

- If your eye will not be to the eyepiece the moment you release the shutter, close the eyepiece shutter by pushing the lever clockwise. This will prevent stray light from entering and adversely affecting the exposure.



18.1 Stopped-down AE

1. Following the procedure on p. 40, set the shutter dial to "A."
2. Look into the viewfinder and focus the subject.
3. Turn the lens' aperture ring to the desired aperture.
4. Unlock the stop-down slide. To do this, push it in and then release it; the slide will unlock and its red line can be seen.
5. The shutter speed is automatically selected according to the aperture set on the aperture ring.
If the meter needle is in either exposure warning zone, turn the aperture ring until the needle moves out of the zone.

Overexposure, underexposure and camera shake warnings are the same as for aperture priority AE.



incorrect exposure

correct exposure

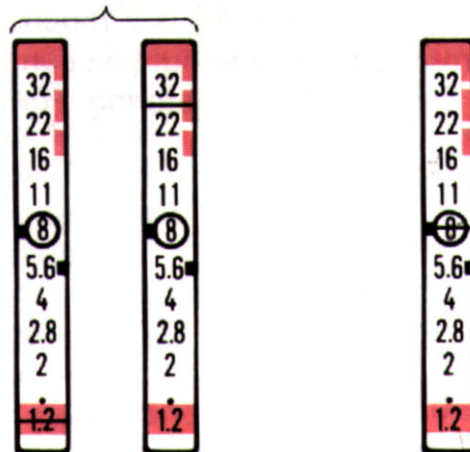

18.2 Match-needle Metering

To meter the subject manually, simply disengage the shutter dial from "A." The shutter speed scale will disappear, and the aperture scale and shutter speed display will appear to the right of the field of view. Then set the shutter speed and aperture in the usual manner, matching the meter and aperture needles in the viewfinder.

18.3 Stopped-down (Fixed-index) Metering

Although stopped-down AE is a much simpler and faster method of metering, you can still use fixed-index stopped-down metering.

Note Use of the following accessories is limited when the AE Finder FN is attached:

- Early TS 35mm f/2.8 lenses: The lens' shift knob will touch the finder as you rotate the lens, preventing full rotation.
- Early Auto Bellows: The finder will touch the bellows' rear standard as you rotate the camera, making vertical shots impossible.

For details concerning modification of either accessory, please contact the nearest Canon authorized service facility.

19 Shutter-priority AE



When the AE Power Winder FN or AE Motor Drive FN is attached to the New Canon F-1, a choice of shutter-priority AE or manual exposure is available according to the shooting situation and your personal preference.



For shutter-priority AE, simply turn the lens' aperture ring to the "A" mark and turn the shutter dial to the desired speed. The aperture scale and the shutter speed which you have selected are displayed, as in match-needle metering, to the right of the field of view. The aperture needle, however, disappears from view. When you press the shutter button halfway, the meter needle will point to the aperture which the camera has selected automatically. If the meter needle points to either the over- or underexposure warning mark, simply turn the shutter dial until the needle moves away from the mark.

With both the AE Finder FN and the power winder or motor drive attached, any of

the various exposure modes can be used. For aperture-priority AK, first disengage the lens' aperture ring from the "A" mark. Then set the shutter dial to "A," and manually select an aperture. The camera will select the shutter speed automatically.

For manual exposure, make sure that both the lens' aperture ring and the shutter dial are disengaged from the "A" setting. Then set the shutter speed and aperture manually, aligning the two needles in the viewfinder in the usual way.

For further details, see the power drive's instructions.

Note

In general, center-weighted average metering is recommended for AE photography. Please see p. 48 for further details.

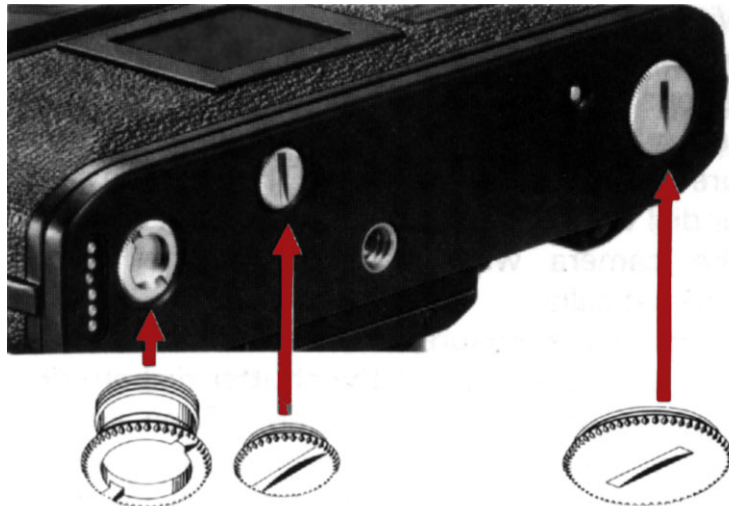

Socket Covers

There are three socket covers in the baseplate of the camera. All three must be removed to attach the motor drive; for the power winder, only two (2) and (3) must be removed. Do not remove them unless you intend to attach one of these AE power drives. Above all, NEVER remove the rewind coupler cover (1) when film is loaded in the camera or the film will be exposed to light.

CAUTION

- Do not set both the shutter dial and the lens' aperture ring to the "A" settings. Otherwise, the lens will stop down to the smallest aperture and the camera will operate in aperture-priority AE. Depending on the lighting conditions, this may result in undesirably slow shutter speeds.

- After removing the power winder or motor drive, do not forget to remove the lens' aperture ring from the "A" mark or the shutter will not release when you press the shutter button.
- Before attaching the finder or motor drive, wipe the contacts with a clean, dry cloth to prevent poor contact from dirt.

20 Meter Coupling Range

With an FD 50mm f/1.4 lens and ISO 100/21° (ASA 100/21 DIN) film, the New Canon F-1's built-in exposure meter couples within a range of EV.- 1 (4 sec. at f/1.4) to EV 20 (1/2000 sec. at f/22). In aperture-priority AE or stoppeddown AE, the coupling range is EV-1 to EV 19 (1/1000 sec. at f/22).

EV (Exposure Value) is a numerical value of exposure which is based on proper combinations of shutter speed and aperture. The camera's EV coupling range varies with lens speed and ISO film sensitivity.

21 Metering Sensitivity Areas

With the New Canon F-1, a special optical element in each focusing screen determines the metering sensitivity area. Thus the metering area can be changed, according to the subject you are shooting and the lens in use, simply by replacing the focusing screen.

There are three different light measuring areas available, each designed to suit particular metering requirements.

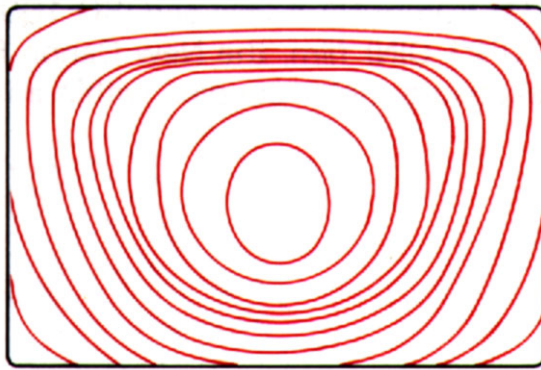

1. Center-weighted Average Metering

With this system, the meter reads the entire viewing area with special emphasis on the central portion where the subject is most likely to be. It can be used for general photography, and is recommended especially for AE photography.

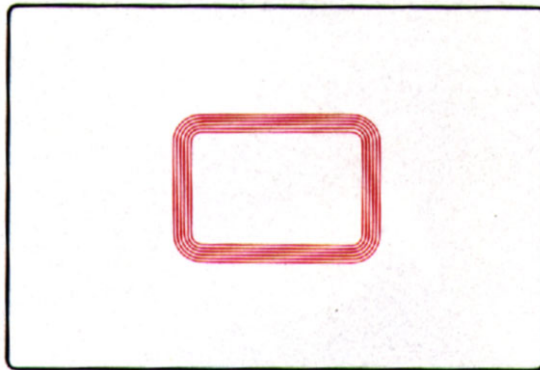

2. Selective-area Metering

The selective-area system, with its 12% coverage, allows you to meter a certain portion of a scene. It, too, is suited for all-around use, and is particularly effective for metering highcontrast scenes, such as landscapes with a bright sky and backlit subjects. Manual exposure is recommended for optimum results. This system can be used for AE photography, but special attention must be paid to ensure that the subject is within the 12% metering area.

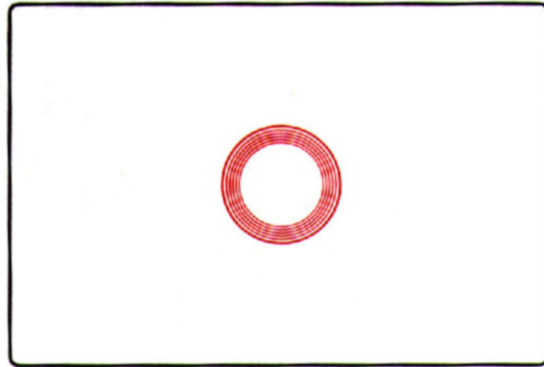

3. Spot Metering

Spot metering is ideal for subjects which require carefully-aimed, precise measurement. Since the metering area is 3% of the field of view, you can select a small, exact area from the overall scene. It is especially advantageous for metering inaccessible subjects and when shooting with a telephoto lens. Also very effective for stage and close-up photography. This system is not suitable for AE photography; for best results, use manual exposure metering.

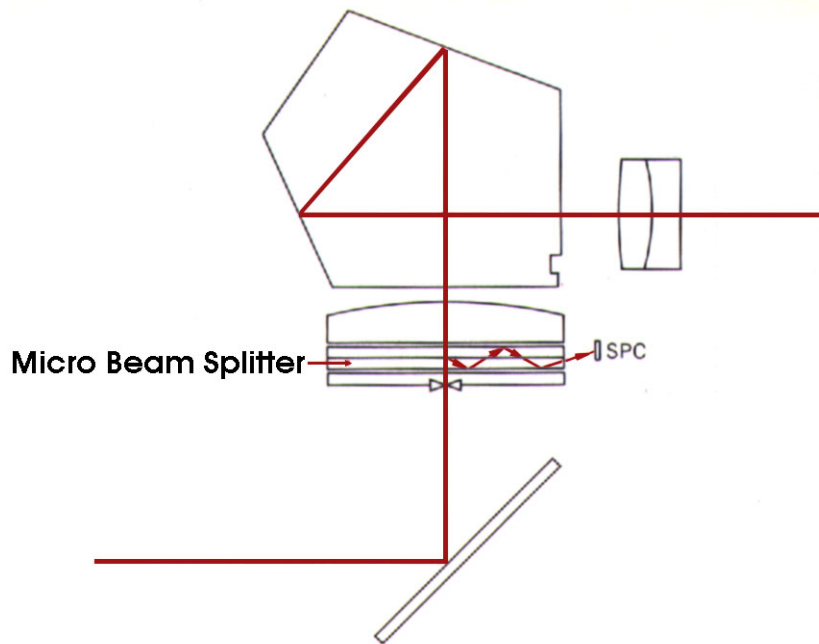

Since the optical element is located in close proximity to the focal plane, this new system of metering sensitivity distribution ensures extremely accurate results. The actual measuring area, which is slightly shaded, can be seen in the center of the viewfinder with selective-area and spot metering. It is not visible, however, with center-weighted average metering.



22 Exposure Compensation

With center-weighted average metering, the camera's meter reads the average brightness of the subjects in a scene, with special emphasis placed on those in the center. Certain lighting conditions, however, may necessitate exposure correction. If there is bright light, such as the sun or a window, behind the subject, the meter may be influenced by that light and your subject will be underexposed. On the other hand, if you are shooting an actor on a dimly-lit stage, the meter may be "fooled" and your subject will be overexposed. Thus it is preferable, whenever possible, to meter the part of the scene which requires the most accurate exposure. This is particularly true if the scene has strong contrasts in brightness.

Selective-area metering is less influenced by the surrounding lighting conditions provided the main subject covers most of the 12% metering area. However, if the subject is quite small, some exposure compensation may still be necessary.

Since spot metering allows you to select a small, exact area, it is virtually unaffected provided the subject fills the 3% center spot.

Exposure compensation may also be necessary if you wish to intentionally overexpose or underexpose the shot for creative effect.

You can compensate exposure in any one of the following ways:

- Manual Exposure
- Exposure Compensation Dial
- Adjust the ISO Setting



1. Manual Exposure

After setting the desired shutter speed, turn the aperture ring until the aperture needle aligns with the meter needle. You can now over- or underexpose the subject in one-half f/stop increments simply by turning the aperture ring to a larger or smaller aperture. Note that the diameter of the aperture needle's circle is equivalent to one f/stop. This method of exposure correction is useful, for example, when shooting a subject with strong backlight.

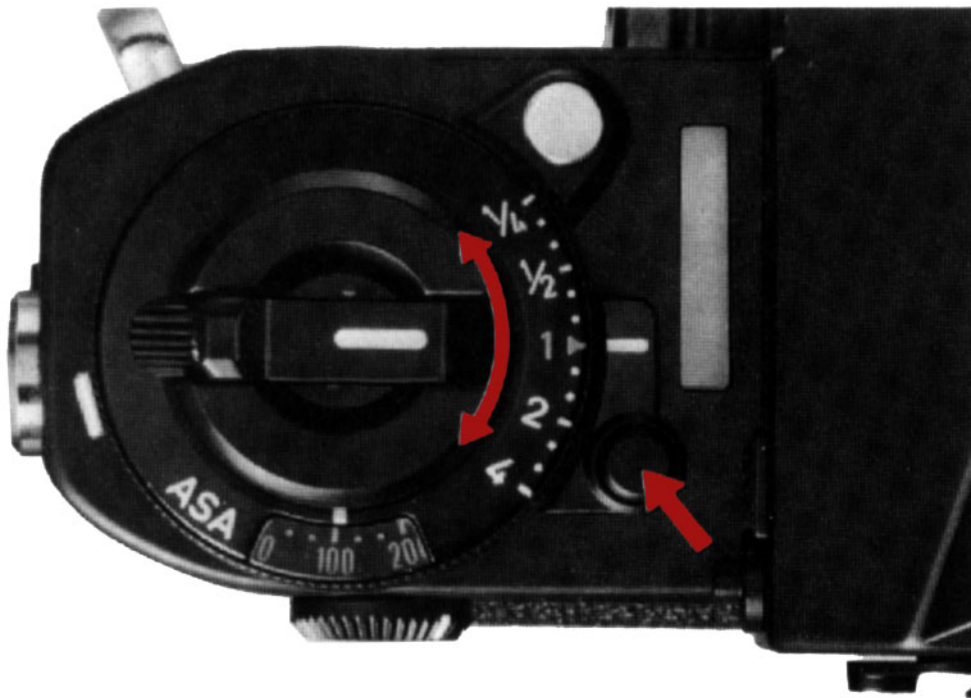

chart	ISO 6	1/4 .. 1/2 .. 1
	ISO 12	1/4 .. 1/2 .. 1 .. 2
	ISO 25—1600	1/4 .. 1/2 .. 1 .. 2 .. 4 ..
	ISO 3200	1/2 .. 1 .. 2 .. 4
	ISO 6400	1 .. 2 .. 4

2. Exposure Compensation Dial

The exposure compensation dial allows you to make exposure corrections in increments as small as 1/3 f/stop. To make a correction, simply turn the dial, while pressing the lock release button, until the desired correction aligns with the index.

The whole numbers are for increasing exposure while the fractions are for reducing exposure. The numbers "2" and "1/2" are equivalent to one f/stop (or one step of the shutter dial), while "4" and "1/4" are equivalent to two f/stops (or two steps of the shutter dial). The intermediate settings indicate increments of 1/3 f/stop. The table above shows which settings can be used depending on the ISO film speed. This means of exposure compensation is possible regardless of the exposure mode, and is useful for bracketing. It is particularly advantageous for AE photography since it allows you to adjust the exposure quickly.

IMPORTANT Once you have made an exposure correction, do not forget to reset the dial to "1." Otherwise, all following frames will be incorrectly exposed.

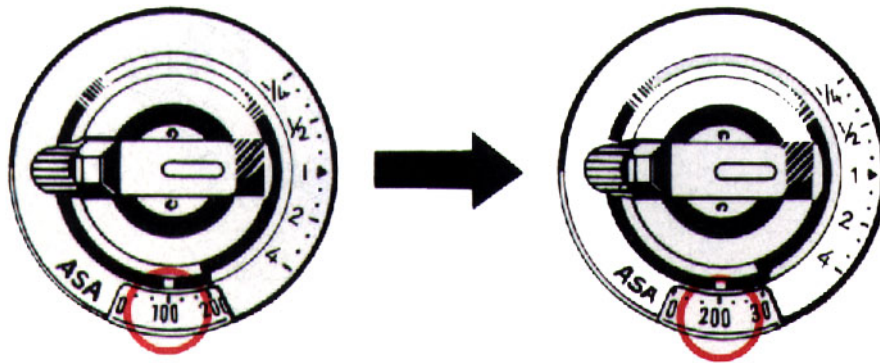

3. Adjusting the ISO Rating

You can also correct exposure in manual or AE by changing the film speed setting on the camera.

A film with an ISO rating twice that of another film requires only half the amount of light for correct exposure. Thus if you have an ISO 100 film loaded and you wish to underexpose the subject one f/stop, simply change the ISO setting to ISO 200. It is possible to over- or underexpose the subject by up to two f/stops using any of these three methods. For compensating more than two f/stops, make the adjustment by changing the ISO rating or by manually setting the aperture and shutter speed.

Note

When it is difficult to determine exactly how much correction to make, bracket the exposure. using any of the three methods.

4. "Pushing" the ISO Rating

There may be occasions when, due to insufficient lighting, you are forced to use undesirably slow shutter speeds. In this case, you can "push" the ISO setting on the camera to a higher value. Usually this is done by multiplying the normal ISO film speed by a multiple of two, such as two or four. The entire roll of film must be shot at the "pushed" ISO setting; otherwise, exposure will not be correct for all frames. It is also necessary to inform the developing lab of the change in the ISO rating or the film will be incorrectly developed. Hbwever, since not all films can be "pushed" with acceptable results, it is recommended to read the film data sheet or other photographic literature before you try this technique.

23 Rewinding the Film

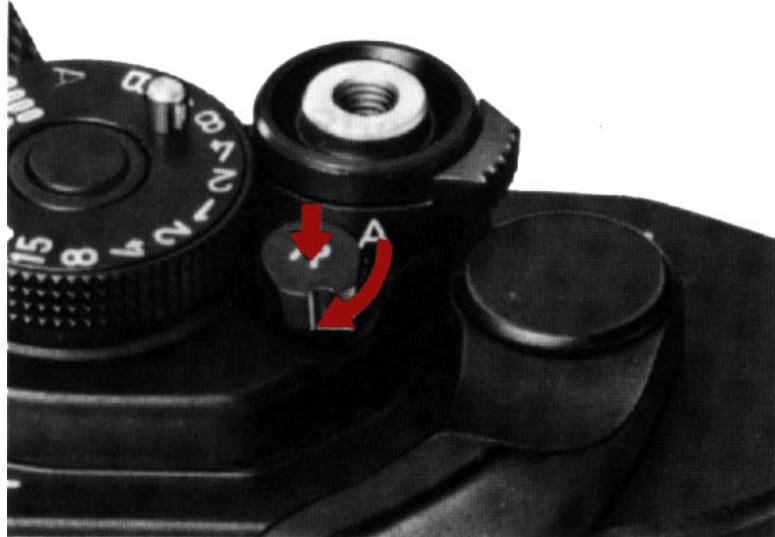

When you have reached the end of the film, the film advance lever will stop before the end of its stroke.

1. Turn the rewind lever in the direction of the arrow and push it down until it locks.
2. Unfold the rewind crank and turn it in the direction of the arrow. You will hear a sound as you turn the rewind crank which indicates the film is being rewound. When you no longer hear the sound, the film is completely rewound.
3. Pressing the safety stopper, open the camera back by pulling up the rewind knob and take out the film. Be sure to shield the film from direct sunlight while unloading.

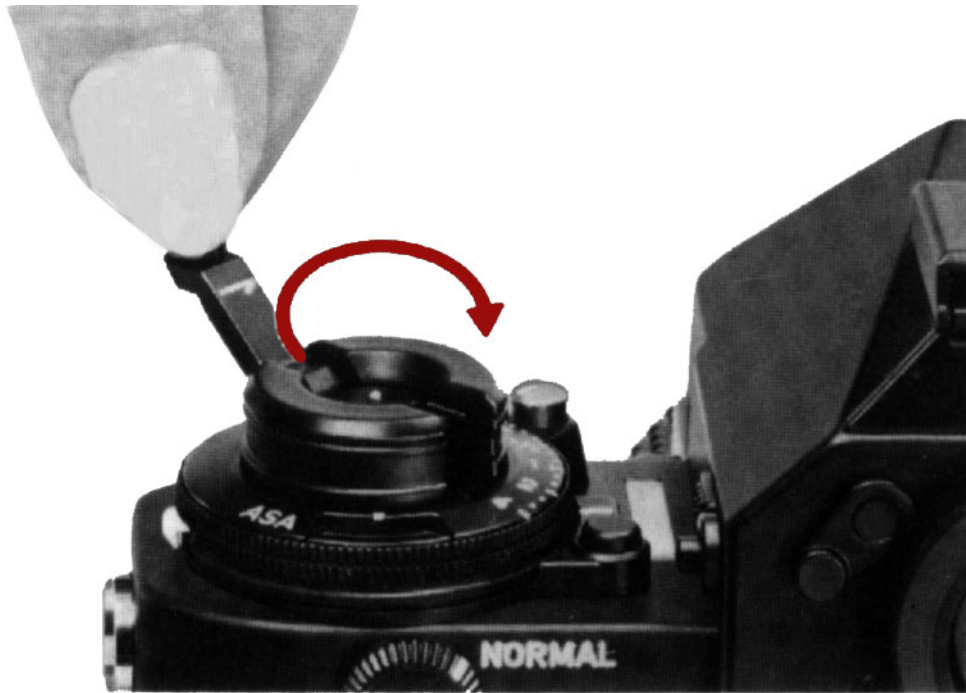

Notes

- If you are not sure the rewind lever is engaged, or if you have accidentally engaged it, gently press the shutter button and the lever will pop back up.
- The frame counter does not count backwards as you rewind the film.
- The frame counter will return to "S" and the rerwind lever will automatically disengage when you open the camera back.

24 Depth of Field

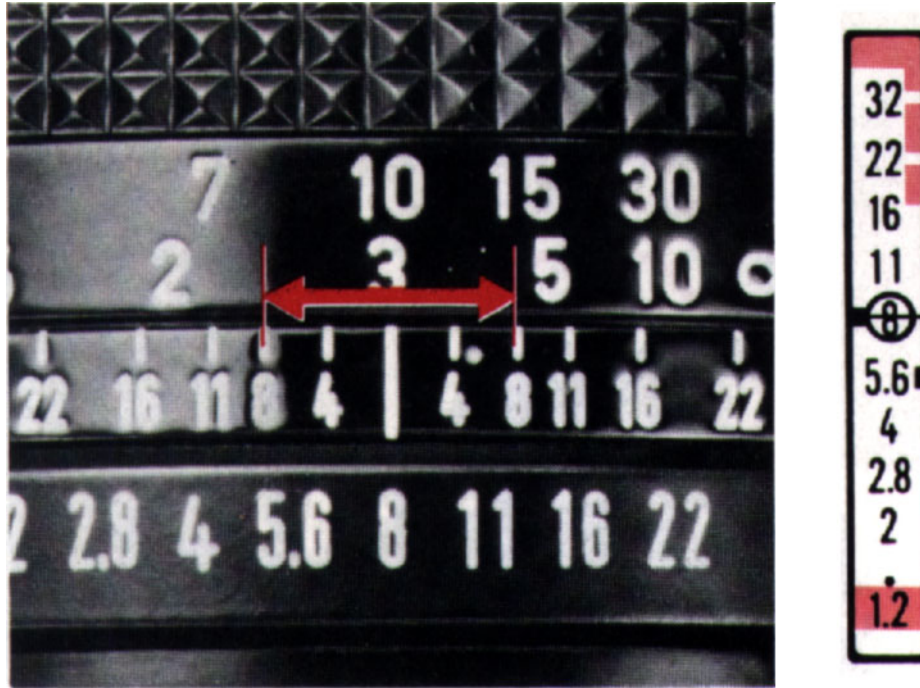

There are two ways to check depth of field. One is by using the depth-of-field scale on the lens. This is a scale of f/stops repeated on each side of the distance index.

1. First focus. Then press the shutter button halfway and note to which f/stop the meter needle points in the viewfinder. Find the two f/stops on the depth-of-field scale which correspond to that number.

2. Draw imaginary lines from those two numbers to the distance scale. The effective depth of field lies between those two distances.



You can check depth of field visually in the following way:

- Focus the subject. Then press the shutter button halfway and note to which f/stop the meter needle points in the viewfinder.
- Turn the lens' aperture ring to that f/stop.
- Push in and then release the stop-down slide so that it unlocks and you can see its red line. Now, just by looking at your subject through the viewfinder, you can see the range of sharp focus.
- After checking depth of field, push in and then release the stop-down slide.

Note

It is impossible to release the stop-down slide when the lens' aperture ring is on "A." If you are using the camera in shutter-priority AK, first disengage the lens from "A" and set the working aperture. After checking depth of field, return the aperture ring to the "A" mark.

25 Self-timer



- First make sure the film is advanced to the next frame.
- Turn the self-timer/lock lever to "S."
- Focus the subject and take a meter reading. Do not set the shutter dial to "B" because the self-timer will not function on this setting.
- Press the shutter button. A "beep-beep" sound will be emitted. The shutter will be released automatically ten seconds later. At two seconds before shutter release, the camera will begin to beep at a faster rate.
- Following exposure, turn the lever back to "A" or "L" unless you want to use the selftimer for the next shot.

Notes

- In shutter-priority AE, the camera is designed to reflect any last-second changes in lighting and will not set the exposure until an instant before the shutter itself is released.
- In aperture-priority AE, the camera sets the shutter speed the moment you press the shutter button. Therefore, do not stand in front of the lens while you press the shutter button or exposure may be incorrect.

- If you have started the self-timer and wish to cancel its operation, press the battery check button.

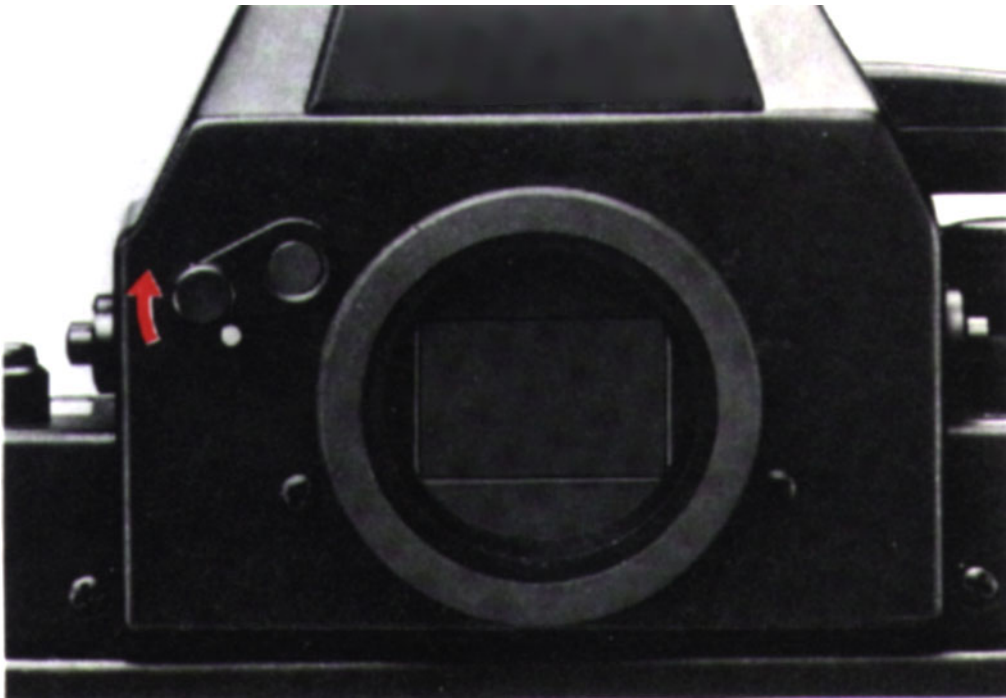

Eyepiece Shutter

If your eye will not be to the eyepiece during shutter release, close the eyepiece shutter to prevent stray light from entering and causing underexposure. This is particularly important in self-timer AE photography, and also applies to remote control and night photography.

To close the eyepiece shutter, push the lever clockwise. The red dot is a reminder that the eyepiece shutter is in place.



26 Multiple Exposures



The New F-1's provision for multiple exposures allows you to easily make two or more exposures on the same frame for creative effect.



1. First advance the film to the next frame.
2. Then take up any film slack. To do this, unfold the rewind crank and gently turn it in the direction of the arrow until it stops.
3. Focus, compose your subject and take the picture.
4. Turn and press down the rewind lever in the usual manner; the film will now retain stationary for multiple exposures.
5. Gently turn the film advance lever. This will cock the shutter for the next exposure.

You can make any number of exposures on the same frame simply by repeating steps 3, 4 and 5 above in the proper order. Each time you turn the film advance lever, the camera's frame counter will advance once. There is, however, a possibility of slight movement of the film if you make an excessive number of exposures on the same frame.

If you have engaged the rewind lever for multiple exposure and wish to cancel it, lightly press the shutter button before turning the advance lever. Note that it is not advisable to make multiple exposures on the first or last several frames due to possible film curl which may adversely affect image registration.

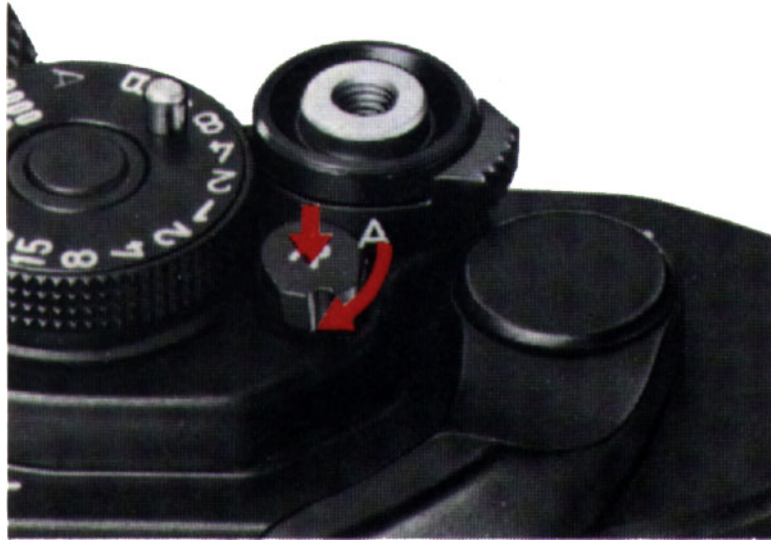

Note

Multiple exposures are also possible when the AE Power Winder FN or AE Motor Drive FN is attached to the camera. To release the shutter, use either of the two shutter buttons of the power drive. To return to normal shooting, cap the lens and take a blank shot using the camera's shutter button.

27 Exposure in Multiple Exposures

Generally, the first exposure of a series should be of a relatively dark subject so that the image in the next exposure will show up clearly. For best results, it is advisable to decrease the exposure for each shot. Depending on the situation, there are several ways to do this. One way is to change the ISO setting to a higher value as described earlier. In this method, you must first decide how many exposures you want to make on the same frame. If a double exposure, make ISO exposures at twice the normal ISO rating; if a triple exposure, make all three exposures at three times the normal ISO rating, and so forth.

Another way to correct exposure is to use the exposure compensation dial. This method is the same as that of changing the ISO. That is, for a double exposure, set the dial to "1/2" for both exposures; for a triple exposure, at the setting between "1/2" and "1/4", and so on. Both methods described above are merely guidelines, and your technique will benefit greatly from practice.

Number of Multiple Exposures	Exposure Compensation Scale
Double	1/2
Triple	Between 1/2 and 1/4
Quadruple	1/4

28 Flash Photography



28.1 AE Flash Photography with Speedlites 011A, 133A, 155A, 166A, 177A, 188A, 199A, 533G and 577G.



Once the Speedlite is attached to the camera and its pilot lamp is glowing, the camera switches automatically to the X sync speed of 1/90 sec. provided the shutter dial is not on "B."

In addition, the meter needle points simultaneously to the aperture which you have set on the back of the Speedlite. Thus you do not have to take your eye away from the viewfinder; as soon as the meter needle points to the auto working aperture, the flash is ready. Now simply turn the lens' aperture ring until the aperture needle aligns with the meter needle.

With the AE Finder FN attached and the shutter dial on "A," the camera will switch automatically to the X sync speed of 1/90 sec. and the meter needle will

point to the right of 1/60 sec. Set the same aperture on the lens as that set on the Speedlite.

With the power winder or motor drive attached and the lens' aperture ring set to the "A" mark for shutter-priority AE, the camera will automatically switch the shutter speed to 1/90 sec. and the aperture to the f/stop which you have set on the Speedlite as long as the shutter dial is not on "B."

After the shutter is released, the camera automatically switches back to the speed actually set on the shutter dial until the Speedlite's pilot lamp glows again.

28.2 Slow-sync Flash Photography

With Speedlites 199A, 533G and 577G, you can select a shutter speed slower than 1/90 sec. The advantage of slow-sync flash photography is that the background in the picture will be lighter. You can choose among three working apertures on each of these Speedlites for optimum control of depth of field. For this technique, first set the AUTO/MANU switch of the Speedlite to "MANU." Then turn the camera's shutter dial to any speed from 1/60 sec. to 8 seconds. The picture will be taken at the speed you have set on the shutter dial and the flash will fire at the release of the first shutter curtain. If the shutter dial is set to a speed from 1/2000 to 1/125sec. or "S", the shutter speed will automatically switch to 1/90 sec. As in normal AE flash photography, the meter needle will point to the aperture which you have set on the Speedlite as soon as the pilot lamp lights up. Simply turn the aperture ring until the aperture needle matches the meter needle.

With the motor drive or power winder attached and the lens' aperture ring set to the "A" mark, the aperture will be controlled automatically as well.

IMPORTANT

Before mounting a flash unit, make sure its power switch is OFF.

Note

If using a viewfinder which does not have an accessory shoe, such as the Waist-Level Finder FN connect the Speedlite to the camera's PC socket via a synchronization cord. Then turn the shutter dial to "t" (1/90 sec.) and set the same aperture on the lens as that set on the flash unit.



28.3 General Flash Photography

When using an automatic flash unit other than a Canon Speedlite, first turn the shutter dial to "1/90" (1/90 sec) Then turn the aperture ring to the same aperture which you have set on the flash. With the shutter dial on "f," other types of electronic flash units can be synchronized either through the hot shoe or via the PC socket on the side of the camera. These allow two separate flash units to be fired simultaneously. Set the shutter dial according to the information in the table on the following page.

When shooting with a flash bulb or a manual flash unit, calculate the aperture with a guidenumber formula or with the calculator dial if the flash unit has one. Turn the lens' aperture ring to that aperture.

CAUTION

It is recommended to use a Canon flash unit on this camera. Using a flash or flash accessory of another make may cause the camera to work improperly or even possibly damage the camera itself. If you use a non-Canon flash, turn off the unit before you attach it to or remove it from the camera's hot shoe. Before removing the flash, press the flash test button if it has one to discharge any power remaining in the capacitor. These are merely precautions; following these steps will not necessarily prevent the camera from being damaged by the flash unit.



Infrared Index Mark

Infrared light has longer wavelengths which focus on a plane slightly behind that of ordinary visible light. It is necessary, therefore, to slightly adjust the focus of the lens when using black-and-white infrared film. The infrared index mark engraved on the lens is used for this purpose. After focusing in the usual way, note the small red dot engraved on the lens barrel to the right of the distance index, and turn the focusing ring to align the focused distance with this dot. For instance, if the focus is at 10m on the distance scale, turn the focusing ring to align the 10m mark with the red dot. After making this correction, you can release the shutter. When using black-and-white infrared film, visible light must be kept out by means of a deep red filter, such as an R1 or Kodak Wratten 87. The position of the infrared index mark has been computed for the use of infrared film with peak sensitivity at 800nm, such as Kodak IR 135.

For further details, refer to the film manufacturer's instructions.

29 Shooting with Close-up Accessories





With few exceptions (noted in the instructions for the accessory), stopped-down metering is necessary whenever you insert an accessory between the camera and lens for close-up photography.

- If you insert an accessory designed for AUTOMATIC diaphragm control, such as the Auto Bellows or Bellows FL, between the camera and ANY lens, follow the steps for stopped-down metering.
- If you insert an accessory designed for MANUAL diaphragm control, such as M Extension Tubes or Bellows M, between the camera and a NON-FD lens, follow the steps for stopped-down metering. Turn the A-M ring of an FL lens to "M" for taking the shot (not necessary if Canon Macro Auto Ring and Double Cable Release are used).
- If you insert in accessory designed for MANUAL diaphragm control between the camera and an FD lens, unless you use the Canon Macro Auto Ring and Double Cable Release, first set the lens for manual diaphragm control before mounting it on the accessory. Then follow the steps for stopped-down metering.

Note

The instructions with the accessory will tell you whether or not manual diaphragm control is necessary. The procedure differs according to the type of lens.



Manual Diaphragm Control

FD Lenses without Chrome Mount Ring except for FD Macro Lenses

1. Insert the slot of the accessory manual diaphragm adapter over the tip of the automatic aperture lever at the rear of the lens. Push the lever counterclockwise and lower the adapter into the groove.



2. Mount the lens on the accessory.
The diaphragm blades will now open or close as you turn the aperture ring. When the manual diaphragm adapter is attached, never mount the lens directly on the camera or on an accessory designed for automatic diaphragm control, such as the Auto Bellows or Bellows FL.

FD Lenses with Chrome Mount Ring and FD Macro Lenses (except for FD 200mm f/4 Macro Lens)

1. Push the automatic aperture lever at the rear of the lens counterclockwise until it automatically locks.
2. Mount the lens on the accessory.

Note

Some of these lenses have an additional lock lever. With these lenses, push the

automatic aperture lever fully counterclockwise, then push the lock lever to "L". Be sure to reset the automatic aperture lever to its normal position before mounting the lens directly on the camera. In the case of a lens with a lock lever, switch it back to the position of the white dot.



Film Plane Indicator

This mark, engraved on top of the camera body, indicates the exact position of the film plane. It is useful for measuring the exact shooting distance from film to subject in closeup photography. Distances on the lens' distance scale are calibrated from this mark. It is not used in general photography.

Note

The aperture ring of an FD lens must be removed from "A" before you mount the lens on any of these close-up accessories except for FD-U Extension Tubes and Extenders FD 2x and FD 1.4x, which are designed for normal full-aperture metering.



30 System Accessories



30.1 Canon AE Motor Drive FN

The AE Motor Drive FN is designed as an integral part of the New Canon F-1 system. Attached to the camera, this accessory redefines the meaning of automatic in motorized SLR photography by providing you with automatic film winding and power rewinding as well as shutter-priority AE, the ideal exposure mode for sports, action and candid photography. Three separate power sources, the Battery Pack FN, Ni-Cd Pack FN, and the High Power Ni-Cd Pack FN, are available to suit your preference and the shooting situation. With Battery Pack FN or High Power Ni-Cd Pack FN, sequential shooting at up to five frames per second is possible; Ni-Cd Pack FN enables film advance at 4.5 frames per second. The motor drive is equipped with two shutter buttons for maximum ease of operation when shooting in either the horizontal or vertical format, and a remote control socket.



30.2 Canon AE Power Winder FN

Designed to increase the versatility of the New Canon F-1, the AE Power Winder FN advances the film automatically in single-frame or continuous shooting at a maximum two frames per second. In addition, it converts the camera to shutter-priority AK. The power winder has two shutter buttons for horizontal or vertical shots. A socket is provided for any of the various remote control devices



30.3 Canon Film Chamber FN-100

The Film Chamber FN-100 is one of the system accessories designed for the New Canon F-1. Used in conjunction with the AE Motor Drive FN, the film chamber provides continuous or single-frame shooting capability of up to 100 frames, as well as shutter-priority AE. Yet it is sufficiently light and compact to afford hand-held shooting, making it ideal for sports, documentary and action photography where utmost mobility is desired. A special grip and shutter button on the film chamber ensure maximum ease of handling.



30.4 Canon Data Back FN

The Canon Data Back FN is a data-recording accessory designed for use with the New Canon F-1. In addition to the year, month, and day, the letters A to G in both upper and lower case and Roman numerals I to X may be imprinted in up to six characters on the film. Not only can this accessory be used for recording the data on photographs, it may also be used to code them for scientific and other purposes. The data back's special direct contact enables data recording in perfect synchronization with exposure.



30.5 Canon Wireless Controller LC-1

This remote control device uses infrared light to control cameras from a distance. The LC-1 is particularly useful in sports and wildlife photography, news coverage and numerous other fields. The Wireless Controller consists of a transmitter and a receiver. Up to three cameras can be operated on three different channels.

31 Specification

Type:	35mm single-lens reflex (SLR) camera
Format:	24 x 36mm
Interchangeable Lenses:	Canon FD (for fullaperture metering) and Canon FL, R and non-FD (for stopped-down metering) series lenses.
Standard Lenses:	FD 50mm f/1.2L, FD 50mm f/1.2, FD 50mm f/1.4 and FD 50mm f/1.8
Lens Mount:	Canon breech-lock mount.
Exposure Modes:	Match-needle and stoppeddown manual exposure. Shutter-priority AE possible by attaching AE Power Winder FN or AE Motor Drive FN and setting lens' aperture ring to "A." Aperture-priority AE and stopped-down AE possible by attaching AE Finder FN and setting shutter dial to "A." AE flash possible with specified Canon Speedlites.
Viewfinder:	Interchangeable eye-level pentaprism as standard. 97% vertical and horizontal coverage of actual picture area with 0.8x magnification at infinity with a standard lens. Aperture scale with f/stops from f/1.2 to f/32, overexposure and underexposure warning marks, meter needle, aperture needle and battery check/stoppeddown metering index are displayed to the right of the field of view. Shutter speed displayed below aperture scale. Speeds include 1/2000 to 1 see, " S "and "B" in green; full seconds of 2, 4 and 8 are in orange.
Viewfinder Illuminator:	Provided; illuminates aperture scale and shutter speed for 16 seconds when meter mode selector is set to "LIGHT" and shutter button pressed halfway.

Eyepiece Shutter:	Built-in. Keeps out extraneous light during self-timer and remote control operation.
Dioptric Adjustment:	Built-in eyepiece adjusted to standard -1 diopter.
Focusing Screen:	Standard split-image/microprism rangefinder. Twelve other types of interchangeable screens are optionally available.
Light Metering System:	Through-the-lens (TTL) metering by silicon photocell (SPC). Metering area is determined by special optical element incorporated in each focusing screen. Center-weighted average, selective area and spot metering are optionally available by changing the focusing screen.
Meter Coupling Range:	EV -1 (4 sec. at f/1.4) to EV 20 (1/2000 sec. at f/22) with ISO 100 film and FD 50mm f/1.4 lens.
Exposure Preview:	By pressing shutter button halfway.
Meter Mode:	At "NORMAL," meter activated as long as shutter button is pressed halfway. At "HOLD," meter, once activated, stays on for 16 sec. At "LIGHT," meter, once activated, stays on for 16 sees. and viewfinder information is illuminated. Cancellation possible.
Exposure Compensation Dial:	+ - 2 f/stop range in 1/3 f/stop increments: 1/4.. 1/2 .. 1 .. 2 .. 4
Shutter:	Horizontal-travel, titanium focal-plane shutter with four spindles. Eiectromechanical hybrid control. Mechanically controlled at speeds from 1/2000 to 1/125 sec., "d" (1 /90 sec.) and B. Electronically controlled at speeds from 1/60 to 8 sees.

Mechanical Shutter Operation:	By removing battery from battery chamber. Only mechanically controlled speeds can be used.
Mirror:	Instant-return type with shock-absorbing mechanism.
ISO Film Speed Scale:	ISO 6-6400.
Shutter Dial:	1/2000 to 8 sec., "A" (for aperture-priority AE or stopped-down AE with AE Finder FN), "B" (bulb) and "S" (1/90 sec.). Shutter speeds from 1/2000 to 1 sec., "S" and "B" are in white, 2 to 8 sees. in yellow and "A" is in red.
Shutter Button:	Two-step button with electromagnetic release. Mechanical release when battery is removed from the camera. Pressing it halfway activates meter circuit, pressing it fully releases the shutter. Can be locked by setting self-timer/lock lever to "L." With cable release socket.
Self-timer/Lock Lever:	Three positions: "A," "L," and "S". At "L," the shutter button is locked as a safety feature. "S" position is for self-timer operation.
Self-timer:	Electronically controlled. Selftimer/lock lever set to "S." Activated by pressing shutter button. Ten-second delay with electronic "beep-beep" sound. Number of beeps emitted per second increases two seconds before shutter release. Cancellation possible.
Stop-down Slide:	For depth-of-field preview or stopped-down metering.

Power Source:	One 6V lithium (Duracell PX 28L), alkaline-manganese (Eveready [UCAR] No. A544), or silver oxide (Eveready [UCAR] No. 544) battery. Battery lasts about one year under normal use.
Battery Check:	By pressing battery check button. Battery power is sufficient if the meter needle registers above the battery check index.
Cancellation of Camera Circuit:	By pressing battery check button. Cancels shutter operation, self-timer operation, meter reading and viewfinder illumination.
Multiple Exposure:	Possible by engaging rewind lever before winding film advance lever to recock the shutter. Cancelled by lightly pressing shutter button.
Flash Synchronization:	Speeds up to 1/90 sec. with electronic flash; FP- and M-sync at 1/30 sec. or slower. Direct contact at accessory shoe for hot-shoe flash. Threaded PC socket (JIS-B type) for cord-type flash or multiple flash photography. Accessory shoe has contact for normal automatic flash and special contact for AE flash with specified Canon Speedlites.

Automatic Flash:	New Canon Auto Tuning System (New CATS) with specified Canon Speedlites. Shutter speed is automatically set to 1/90 sec. with shutter dial at any setting except B. Meter needle indicates auto working aperture in the viewfinder as soon as Speedlite's pilot lamp glows. Aperture controlled automatically when AE Power Winder FN or AE Motor Drive FN is attached and lens' aperture ring set to "A" mark.
Slow-Sync Flash Rhotography:	Possible with Speedlites 199A, 533G and 577G. Flash synchronizes with shutter speed set at slow settings from 1/60 to 8 secs. Camera switches automatically to 1/90 sec. when shutter dial is set from 1/2000 to 1/125 sec. or "S."
Camera Back:	Opened by pressing safety stopper while pulling up rewind knob. Removable for attaching Data Back FN or Film Chamber FN-100. With memo holder.
Film Loading:	Via multi-slot take-up spool.
Film Advance Lever:	Single-stroke 139° throw with 30° stand-off. Ratchet winding possible.
Frame Counter:	Additive type. Automatically resets to "S" upon opening camera back. Advances during multiple exposures.
Film Rewinding:	By turning rewind leverclockwise and pressing it down and turning rewind crank. Rewind lever automatically resets when camera back is opened and when shutter button is lightly pressed.

Other Safety Devices: Camera will not function when power level is insufficient or when lens' aperture ring is set to "A" and the power winder or motor drive is not attached. Film winding impossible while shutter is in operation.

Dimensions: 146.7 x 48.3 x 96.6 mm
(5-3/4" x 1-7/8" x 3-3/4") body only.

Weight: 795g (28 ozs) body only 1,030g (36-5/16 ozs) with FD 50mm f/1.4.

32 Caring for your Camera

As with any precision instrument, proper care and maintenance involve a few simple rules in addition to common sense. Observing these few rules will keep your New Canon F-1 in top condition at all times.

- The best thing you can do for your camera is to use it regularly. In the event that you must store it for quite a while, first remove it from its case or camera bag. Remove the battery. Wrap the camera in a clean, soft cloth and place it in a cool, dry, dust-free place. If you store the body and lens separately, attach both the body and rear lens caps.
- Keep the camera and lens out of direct sunlight and away from "hot spots," such as the trunk, rear window shelf or glove compartment of a car. Do not store the camera in a laboratory or other such area where chemicals may cause corrosion.
- To keep the camera in top condition during prolonged storage, occasionally insert the battery and take several blank shots to "exercise" the mechanisms. Check the operation of each part before you use the camera following storage.
- Reliable under normal use, your camera can be damaged by water, excessive spray or humidity, sand and shock. Clean it especially well after you use it in an area with excessive dust or saltwater spray. If you accidentally drop it in water, it may be irreparable but take it immediately to an authorized Canon service facility for inspection.
- To clean the exterior of the camera body, first blow off dust with a blower brush. Wipe off smudges with a silicone cloth or chamois leather. If smudges remain on the eyepiece after using a blower brush, wipe it lightly with lens-cleaning tissue which has been moistened with a couple of drops of lens cleaner.
- If the lens surfaces are clean, yet the viewfinder appears dusty, the picture will not be affected by the dust in the viewfinder. If the mirror gets dirty, it will not affect pictures but it may make viewing difficult. Dust it very gently with a blower brush. If further cleaning is necessary, take the camera to the nearest authorized Canon service facility.
- The film chamber needs cleaning from time to time to remove film dust which may scratch the film. Gently dust it out with a blower brush, being careful not to press on the film rails, shutter curtain and pressure plate.

- To clean the lens surfaces, use only a blower brush, cleaning fluid and tissue made specially for cleaning camera lenses. Carefully follow the lens' instructions.

Using the Camera at Very Low Temperatures

When you use the New F-1 in cold conditions, try to protect it from outside air and avoid extreme temperature changes. Condensation forming on a camera and lens taken from subzero outside temperatures into a warm room may cause corrosion. To avoid this, place the camera in a plastic bag while still outdoors. Then seal the bag and take it indoors, leaving the camera in the bag until it gradually reaches room temperature. Generally, this takes about one-half hour. Also, remember that at temperatures below 0°C (32°F), battery power may decrease or fail. Please see page 9 for tips on battery care when shooting in cold conditions.

If you are using the camera in conjunction with the motor drive, the High Power Ni-Cd Pack FN is the most reliable power source for uninterrupted shooting at low temperatures. It can be used as the sole power source for both the camera and the motor drive by attaching the Battery Cord C-FN.

Neckstrap

Thread the tips of the neckstrap through the corresponding rings on the camera so that the tips are on the inside. Then adjust the neckstrap to the length most comfortable for you.